



WATER INFRASTRUCTURE



World-class skills. World-class team.

CONSULTING ENGINEERS

HYDRO

GEOTHERMAL

THERMAL

WATER

INDUSTRIAL

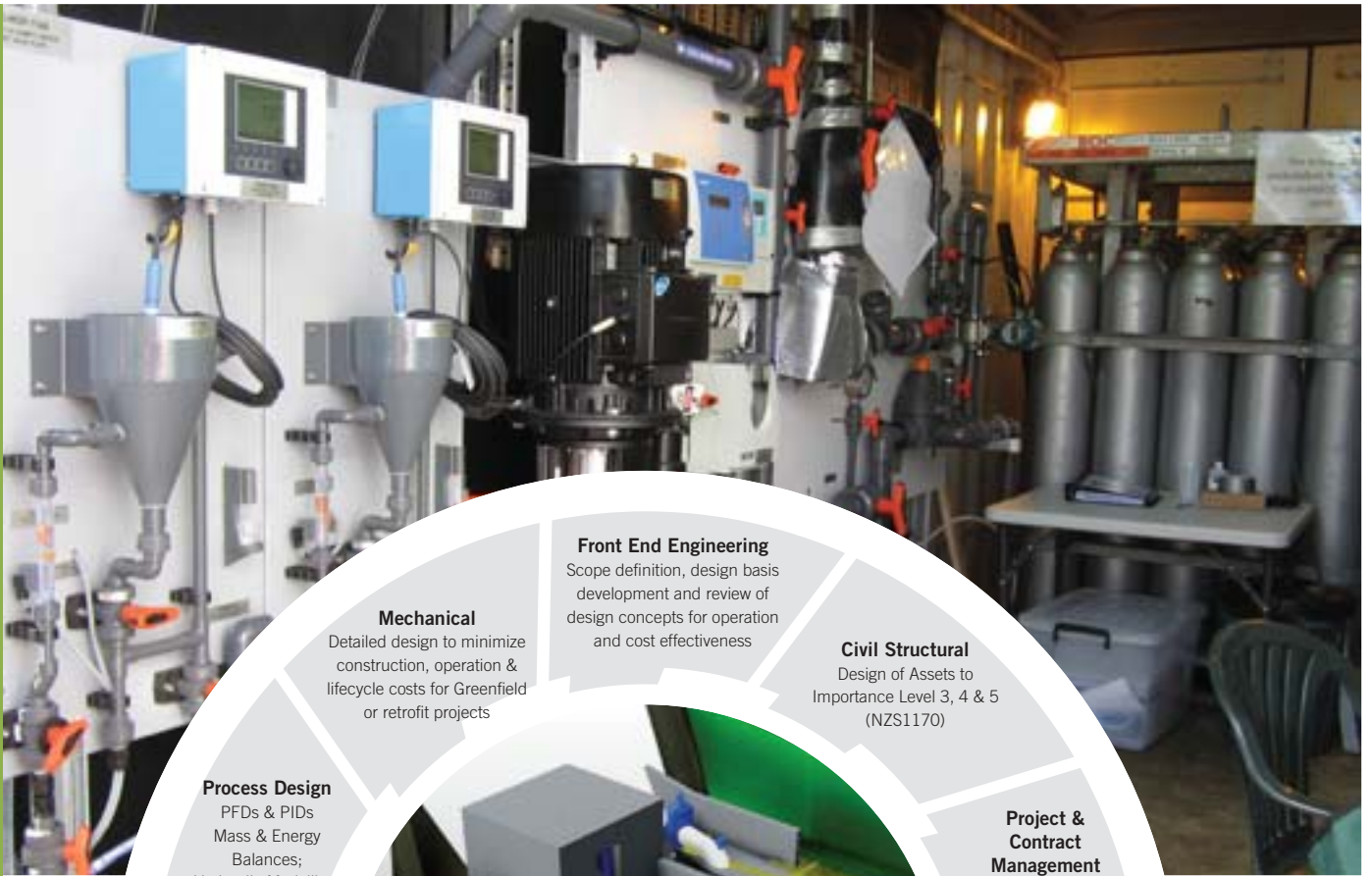

WORLD-CLASS SKILLS.

MTL's core Water Infrastructure design skills available.

** We partner with Electrical and Controls Consultants*

Key Software Capabilities:
 Pipe Stress Analysis – AutoPipe
 Pipe FEA – Nozzle Pro
 Transient Modelling – Hytran
 Head Loss – Pipeflow
 Process – AutoCAD P&ID, HYSYS, WinGEMS
 Piping Design – AutoCAD Plant 3D
 Machine & Equipment Design – Inventor
 Structural Frame Analysis – Microstran
 Structural Design – AutoCAD Structural
 Detailing / Revit Structure

ABOUT MTL

MTL, established in 1994, is a medium sized owner operated engineering design consultancy located in Auckland, New Zealand employing Mechanical Engineers, Designers, Civil and Structural Engineers and Project Managers.

WATER INFRASTRUCTURE

Key projects include Dam Safety Upgrades, Watermain and FCV retrofits, Hydro Generation, Water Treatment chemical dosing / hazardous substance facility upgrades (alum, poly, chlorine, PAC, lime), Plant DWSNZ upgrades, Sludge dewatering, Potable water quality monitoring and control.

PROJECT DELIVERY

Our experienced engineers provide the complete package from project feasibility studies, detailed process, mechanical, civil and structural design, contract management and commissioning for delivery of your water infrastructure project with our Hydro Power Generation and Industrial experience adding value.



Chris Mann
Project & Contract Management
Commissioning Management
HAZOP Facilitator



Don Purdie
Process / Mechanical Design
Project & Contract Management
Commissioning Management
Asset Management



Matt Chubb
Civil and Structural Design
Project & Contract Management
Asset Management



WORLD-CLASS TEAM.



Chris Brown
Mechanical Design
Contract Management
Commissioning
Asset Management



James Powell
Project & Contract Management
Procurement, Scheduling

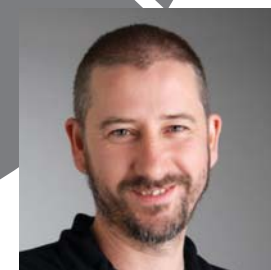

Stephen Kennedy
Design Management,
Detailed Engineering Design

DESIGN PROCESS

MTL's process /mechanical design methodology utilises industry standard P&IDs and Engineering Lists to define the equipment specifications and interfaces. These documents provide the basis for asset management of new plant or retrofits for the life of the installation.

SKILLS & KNOWLEDGE

Collectively, MTL's engineering personnel have significant specialist knowledge and experience to draw on. An overview of some of our key infrastructure engineering projects, personnel and partner consultants can be provided on request.

MTL ROLE

We believe we have a unique offering due to our range of skills and our organisation's size. We are able to work closely with clients and partner consultants to repeatedly provide quality results.

SELECTED MTL WATER PROJECTS

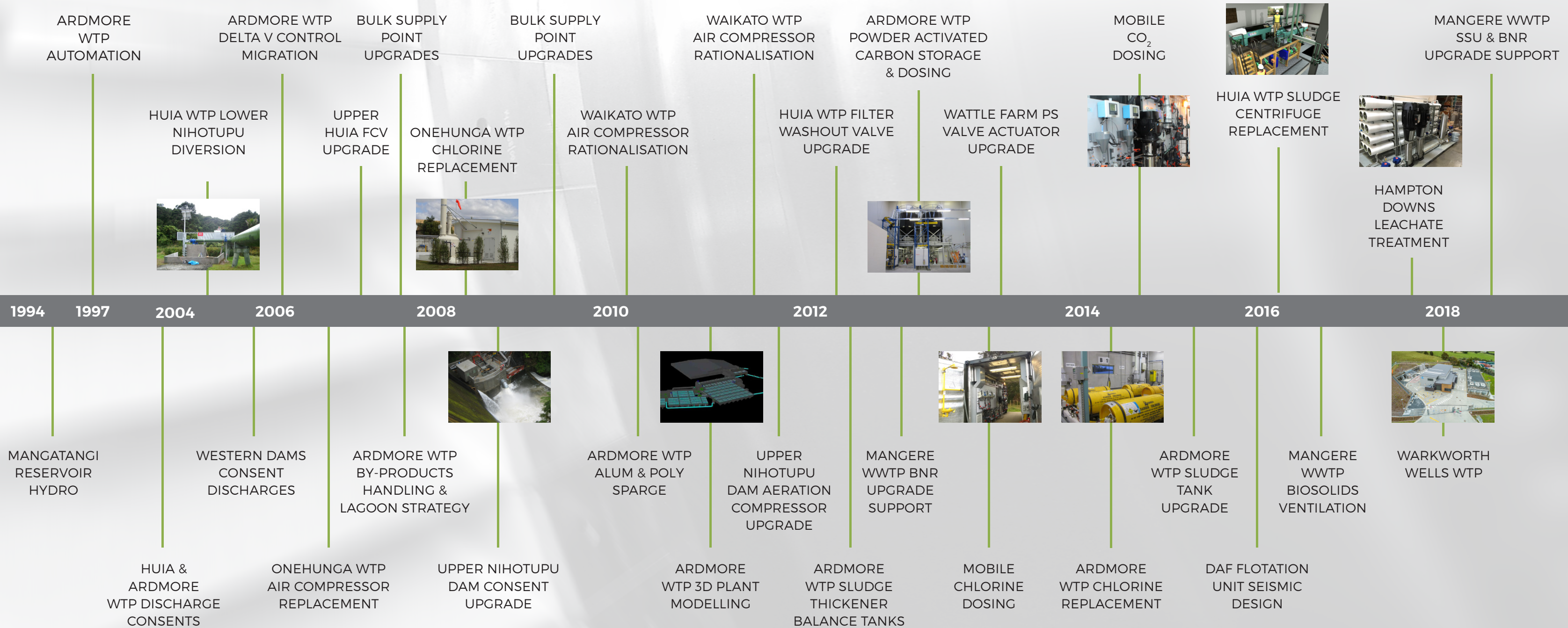

SELECTED MTL PUMP STATION PROJECTS

2004

2006

2008

2010

2012

2014

2016

2018

LIHIR GOLD GPS 20MW & 30MW ACW PUMP STATIONS

AVONDALE PS25 PUMP DRIVE FAILURE INVESTIGATION

AVONDALE PS25 PUMP DRIVE UPGRADE

WATTLE FARM PS VALVE REPLACEMENT

FAIRVIEW PUMP STATION TRANSIENT ANALYSIS & UPGRADE

KARAH A STEAMFIELD BRINE REINJECTION PUMP STATIONS

HOBSONVILLE WW PUMP STATION UPGRADE - NORTHERN INTERCEPTOR PHASE 1

LIHIR GOLD GPS 20MW & 30MW ACW PUMP STATIONS

AVONDALE PS25 PUMP DRIVE FAILURE INVESTIGATION

AVONDALE PS25 PUMP DRIVE UPGRADE

WATTLE FARM PS VALVE REPLACEMENT

FAIRVIEW PUMP STATION TRANSIENT ANALYSIS & UPGRADE

KARAH A STEAMFIELD BRINE REINJECTION PUMP STATIONS

HOBSONVILLE WW PUMP STATION UPGRADE - NORTHERN INTERCEPTOR PHASE 1

2004

2006

2008

2010

2012

2014

2016

2018

HUIA WTP RAW WATER PUMP FAILURE ANALYSIS / UPGRADE

HUIA WTP ALUM PUMP COMMISSIONING

WAIKAKEI STEAMFIELD ARATIATIA BRINE REINJECTION PUMP STATION

WATTLE FARM PS VALVE FAILURE INVESTIGATION & ACTUATOR UPGRADE

LUMUT BALAI STEAMFIELD BRINE REINJECTION PUMP STATIONS

WARKWORTH WELLS TREATED WATER PUMP STATION

CLUTHA & TAIERI FLOOD PROTECTION PUMP STATION CONDITION ASSESSMENT

HAMILTON WTP FLOATING PUMP STATION

HUIA WTP RAW WATER PUMP FAILURE ANALYSIS / UPGRADE

HUIA WTP ALUM PUMP COMMISSIONING

WAIKAKEI STEAMFIELD ARATIATIA BRINE REINJECTION PUMP STATION

WATTLE FARM PS VALVE FAILURE INVESTIGATION & ACTUATOR UPGRADE

LUMUT BALAI STEAMFIELD BRINE REINJECTION PUMP STATIONS

WARKWORTH WELLS TREATED WATER PUMP STATION

CLUTHA & TAIERI FLOOD PROTECTION PUMP STATION CONDITION ASSESSMENT

HAMILTON WTP FLOATING PUMP STATION



SURGE VESSEL REPLACEMENT

Te Kauwhata Water Association, Te Kauwhata, NZ.

PROJECT:

Replacement - End of Life Surge Vessel at Te Kauwhata Pump Station.

MTL ROLE:

MTL managed the replacement of a 5.5m³ surge vessel protecting the Te Kauwhata 450kW pumping station and 1.8km AC water main to the header tank. The station provides up to 22,900m³ per day of untreated water to the surrounding farming and residential areas.

Due to the essential nature of the service, the available outage window for the works could not exceed 6 hours. This tight timeframe represented the main challenge within the project.

MTL project managed the complete process, from the condition assessment of the existing plant, on to specifying and procuring the new equipment, coordinating installation and commissioning.

PROJECT OUTCOME:

The new surge vessel was successfully installed and commissioned within the available timeframe of 6 hours, and the Certificate on Inspection readily issued.

PROJECT PARTNERS:

JJ Niven Engineering Ltd.

"When we approached MTL, we were impressed with the professional commitment to achieve the 6 hour window. There was no 'Plan B'. The open proactive communication to co-ordinate all parties involved in the installation made a challenging project stress free." Andrew Cornwall, Executive Officer TKWA.





WARKWORTH WELLS WATER TREATMENT PLANT

Watercare Services Ltd. Warkworth, NZ.

PROJECT:

3MLD ground source Water Treatment Plant expandable to 8MLD.

MTL ROLE:

As lead designer MTL were responsible for developing the concept design into fully detailed construction drawings for the water treatment plant and rising mains. The flexible design allows the plant to be upgraded in future, with minimal disruption and reduced capital costs, to 4MLD and 8MLD. Significant growth in the region resulted in the project needing to be fast tracked. To facilitate this the design and construction phases had to overlap.

PROJECT OUTCOME:

The new water treatment plant is considered a leading example of a ground water source treatment plant in New Zealand.

PROJECT PARTNERS:

Ergo, CMW, Arup, Holmes, Cassidy Construction, Filtec, Northern Electrical.





WARKWORTH TREATED WATER PUMP STATION

Watercare Services Ltd, Auckland, NZ.

PROJECT:

8 MLD Treated Water Pump Station.

MTL ROLE:

The Warkworth Wells Water Treatment Plant is designed for future growth with initial production of 3 MLD with staged increases to 8 MLD average daily flow (ADF). MTL undertook the treated water pump station and network tie in design to accommodate the initial capacity while providing for the future capacity upgrades.

The treated water pump station and rising mains deliver treated water to two pressure zones:

- the reticulation network & Thompson Rd reservoir.
- the View Rd reservoir.

The design required an intensive pump and drive sizing & selection process, hydraulic modelling and transient analysis. The system includes surge protection via a single 4 m³ surge vessel, expandable to 8 m³ for future flows. MTL's sub-consultant Arup completed the directionally drilled PE treated water rising main design.

PROJECT OUTCOME:

The construction of the pumping station and treated water rising mains were completed in 2018. The plant can be easily upgraded in future with all buried and header pipework sized for future capacities.

PROJECT PARTNERS:

Watercare, Cassidy Construction, Arup, Neo, Filtec, Beca.

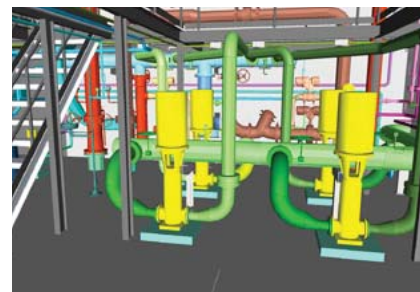



ARDMORE WTP A BLOCK UV DISINFECTION

Watercare Services Ltd, Auckland, NZ.

PROJECT:

260 MLD A Block Filtered Water UV Disinfection for Ardmore Water Treatment Plant.

MTL ROLE:

MTL led the design of a 260 MLD UV Disinfection system retrofit of the A Block filtered water stream (~70% of maximum plant production). Three new 33% duty Wedeco K Series K143 reactors are located inside the existing Chemical Building obsolete 'salt bay'. A combination of CFD and conventional hydraulic modelling has been utilised for UV reactor certification and to minimise head loss. An innovative nominated contractor NZS3916 design build approach has been utilised by WSL to expedite delivery of the project.

PROJECT OUTCOME:

This system will provide a second protozoa barrier to improve water treatment plant resilience and security of the drinking water supply for Auckland during off normal conditions as follows:

- Low raw water quality during storm events that compromise filtered water turbidity, and,
- To enable increased production through A Block (260 MLD from 160 MLD) during major treated water upgrade works planned for Ardmore WTP over the next 2 - 3 years.

PROJECT PARTNERS:

Brian Perry Civil, Neo Consulting.

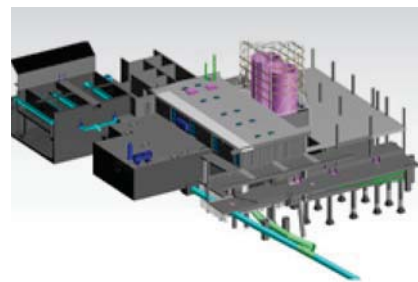
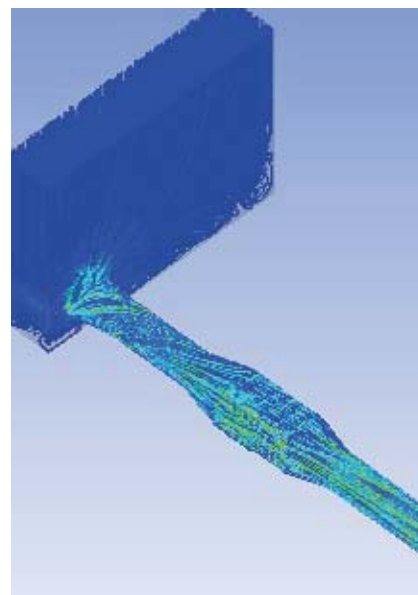
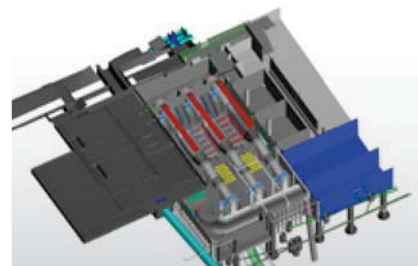



SLUDGE DEWATERING CENTRIFUGE UPGRADE

Watercare Services Ltd, Huia Water Treatment Plant, NZ

PROJECT:

Replacement Centrifuges to support 126 MLD Potable Water Production.

MTL ROLE:

MTL led the project team for Watercare's Sludge Dewatering Centrifuge Upgrade at the Huia Water Treatment Plant. The upgrade saw the replacement of the existing Centrifuges with new higher capacity 'fully automated' Decanting Centrifuges and Thickened Sludge Feed system upgrades to support 126 MLD potable water production. A staged installation of the Centrifuges was required to ensure the Sludge Dewatering Plant remained operational throughout the upgrade. Detailed staging installation methodologies were prepared by MTL to manage the works within the constrained site and to minimise operational disruption to the Sludge Dewatering Plant.

PROJECT OUTCOME:

The two new higher capacity Centrifuges were successfully installed with minimal disruption to the Sludge Dewatering Plant. Both centrifuges are currently in operation.

PROJECT PARTNERS:

Ergo, GEA, Cassidy Construction, TP Engineering, Northern Electrical.





ARDMORE CHLORINE DOSING FACILITY

Watercare Services Ltd, Auckland, New Zealand

PROJECT:

385MLD Chlorine Dosing Facility at Ardmore Water Treatment Plant.

MTL ROLE:

Watercare required a new chlorine dosing facility at their existing water treatment plant at Ardmore to replace aging disinfection systems. MTL as the lead consultant, managed the project from feasibility to handover. This included mechanical, process and civil/structural design, construction supervision and commissioning management. Careful planning went into the design and delivery of the new system to offer redundancy and minimise operational risks during system changeover. As a result, the 'state of the art' unmanned hazardous substance facility, housing a total of 32 x 1 tonne chlorine drums dose to seven separate locations within the treatment plant and incorporates industry best practice safety and control systems including remote automatic drum shutoff, to exceed HSNO regulation and ASNZ2927 requirements.

PROJECT OUTCOME:

The design required a close working relationship with the Client to ensure existing and future operational requirements were clearly understood and met for the critical potable water disinfection process. A staged commissioning process ensured the new dosing system entered service without affecting potable water quality.

PROJECT PARTNERS:

McMahon Electrical, Emerson Process Management, Cassidy Construction, Filtration Technology, Electrix.





ARDMORE, PAC DOSING

Watercare Services Ltd, Auckland, New Zealand

PROJECT:

Ardmore Water Treatment Plant Activated Carbon Dosing System Replacement.

MTL ROLE:

MTL provided fast track design and contract management services for the replacement of Watercare's Activated Carbon Dosing facility. Design services included overall Mechanical & Electrical (MECL Ltd) design, Civil/Structural design and ancillary / services design. The works were split into three packages to best meet the accelerated delivery programme and specialist process requirements.

PROJECT OUTCOME:

The new PAC dosing facility is designed to exceed HSNO Regulation and Hazardous Area Zone electrical requirements for storage and handling of combustible dust. MTL designed the building to be constructed over the operational plant which enabled the new facility to be available for dosing <6 months from H2O's contract award while maintaining PAC dosing capability.

PROJECT PARTNERS:

McMahon Electrical, H2O Engineering, DMCS, Cassidy Construction.





HAMILTON WTP FLOATING PUMP PLATFORM

Hamilton City Council, Waikato, NZ

PROJECT:

90 MLD Floating Pump Platform, Hamilton Water Treatment Plant.

MTL ROLE:

MTL were engaged by Downer to provide a 'fast-track' mechanical and structural design for an innovative floating pump platform to supply raw water to the Hamilton WTP when the Waikato River levels are low. The pump platform, installed March 2016, was designed with 10 m cantilevered pivot arms and walkway fixed to the inlet structure. The design minimised environmental impact on the river and accommodated changes of up to 3 m in river level while providing safe access from the WTP.

The ~40 tonne platform is modular, breaking down into 6 parts for ease of removal, storage and redeployment during summer drought periods. The platform can accommodate 4 pumps, with 3 pumps currently providing a capacity of 70 MLD with future capacity of 90 MLD.

PROJECT OUTCOME:

The project ensures the city of Hamilton can access water from the river during exceptionally-low river levels and provide security of supply for the city's 165,000 residents. The project deferred replacement of the existing intake structure valued at \$26M.

PROJECT PARTNERS:

Downer Group & Ergo Consulting Ltd





ARDMORE WTP SLUDGE BALANCE TANKS

Watercare Services Ltd, Auckland, NZ.

PROJECT:

Two 150m³ Sludge Thickener Balance Tanks.

MTL ROLE:

Watercare required two new in ground sludge balance tanks to be constructed at their Ardmore Water Treatment Plant. The site for the tanks, located on steeply sloping and poor ground, posed significant design challenges.

MTL undertook the detailed design of the reinforced concrete water retaining structures which were supported on reinforced concrete piles taken down to rock.

PROJECT OUTCOME:

MTL managed the design, prepared tender documentation, administered construction, and oversaw construction to a successful completion of the tanks and related drainage works.

PROJECT PARTNERS:

Watercare, HEB Construction Ltd.

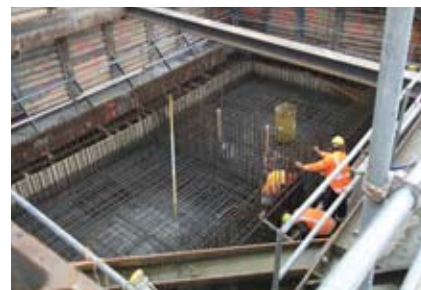



CARBON DIOXIDE DOSING

Watercare Services Ltd, Auckland, New Zealand.

PROJECT:

Mobile CO₂ Dosing Skids for potable water pH control.

MTL ROLE:

Watercare identified the need for two mobile CO₂ Dosing units for temporary deployment to ensure potable water pH compliance with NZDWS as new concrete lined steel watermain are entered into service. MTL provided 'fast-track' process and mechanical design, project management and commissioning services for containerised units with the following features:

- High and low range CO₂ dosing capability
- Dual pH analysers
- Operation at watermain pressures of 200 to 1100 kPa
- Utilising existing water main connections where possible
- Remote monitoring and alarms via SMS
- Mains power or generator connectivity.

PROJECT OUTCOME:

MTL worked very closely with Filtration Technology, the Siemens dosing equipment supplier and 'turn-key' contractor for supply and installation of the dosing units. The dosing units were installed and successfully commissioned within the fast track timeframe of 14 weeks.

PROJECT PARTNERS:

Ergo Consulting Ltd (Electrical & Controls), Filtration Technology/Kinetic/PLNZ.





MANGERE WWTP UPGRADES

Watercare Services Ltd, Auckland, NZ.

PROJECT:

Mangere Wastewater Treatment Plant BNR & SSU Upgrade.

MTL ROLE:

MTL has provided engineering support for the Mangere WWTP Biological Nutrient Removal (BNR) and Solid Stream Unit (SSU) Upgrade projects from 2012 to the present including:

- Secondment of personnel to Watercare for Owner's Engineer roles including procurement support, project and contract management
- Project enabling and temporary works design including service building relocations, temporary digester feed pump station, polymer slicing unit and primary sedimentation tank spray system upgrade;
- Commissioning of the biosolids building ventilation system;
- Contractor design support (piping material take-offs) for HEB Construction, McConnell Dowell for BNR contract for tender and procurement;
- Constructability review and coordination for solid stream unit and bio-solids building;

PROJECT OUTCOME:

Watercare engaged MTL to provide engineering support for the upgrade projects due to our proven track record for successful delivery of brownfield plant retrofits where attention to detail and construction and commissioning experience is required.

PROJECT PARTNERS:

Watercare Services, HEB Construction, McConnell Dowell, Brian Perry Civil, AKWAS.



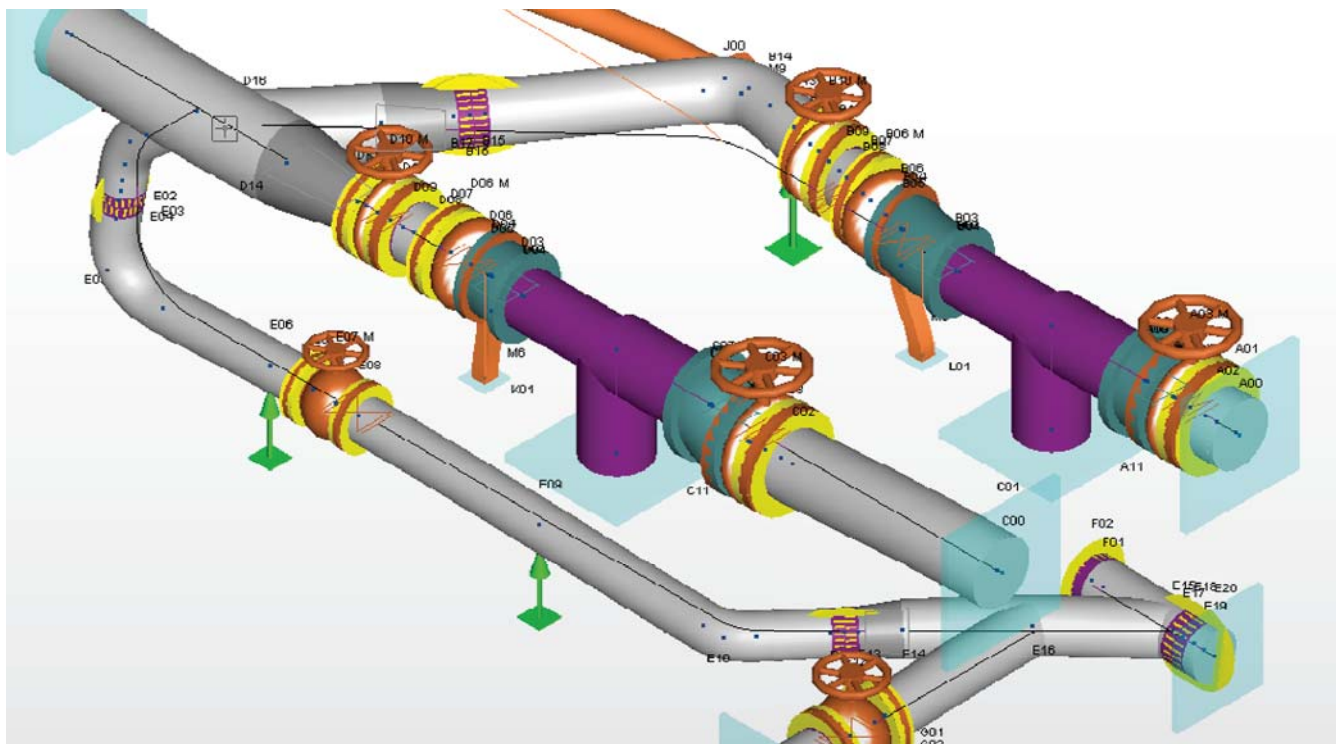

FAIRVIEW PUMP STATION UPGRADE

Watercare Services Ltd, Auckland, NZ.

PROJECT:

40 MLD Fairview PS Transient Investigation and Upgrade.

MTL ROLE:

A significant pressure transient caused the Glenvar watermain to rupture and also damaged valves and piping within the Fairview Ave Pump Station. Watercare engaged MTL to provide technical leadership and develop the interim and permanent repair scope.

Hytran pressure transient modelling of the local network identified issues with the air release valves (ARVs) and pump soft starter settings which was causing premature failure and leakage from the ARV's. Low cost options were developed to address this issue and the performance was verified by the transient model before implementation.

A technical specification, CAPEX estimate and scope of work for the pump station repairs was provided to Watercare. The work included refurbishment of the pumps, replacement of irreparable equipment, pump discharge piping repairs and pipe support upgrades designed by MTL using AutoPIPE & NozzlePRO stress modelling.

PROJECT OUTCOME:

Implementation of the pump station repairs was successfully carried out with minimum disruption to the network supply and only two twelve hour road closures. Installation of anti-shock ARVs has significantly reduced operational transients and eliminated flooding of neighbouring properties.

PROJECT PARTNERS:

Guaranteed Flow Systems Ltd, SGS Ltd, Flowserve Corporation.

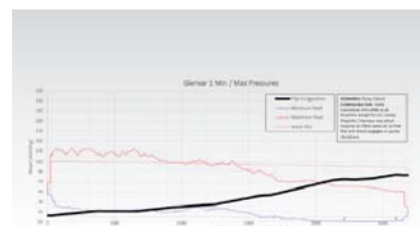
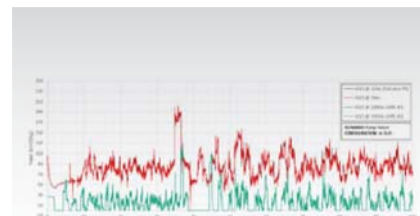

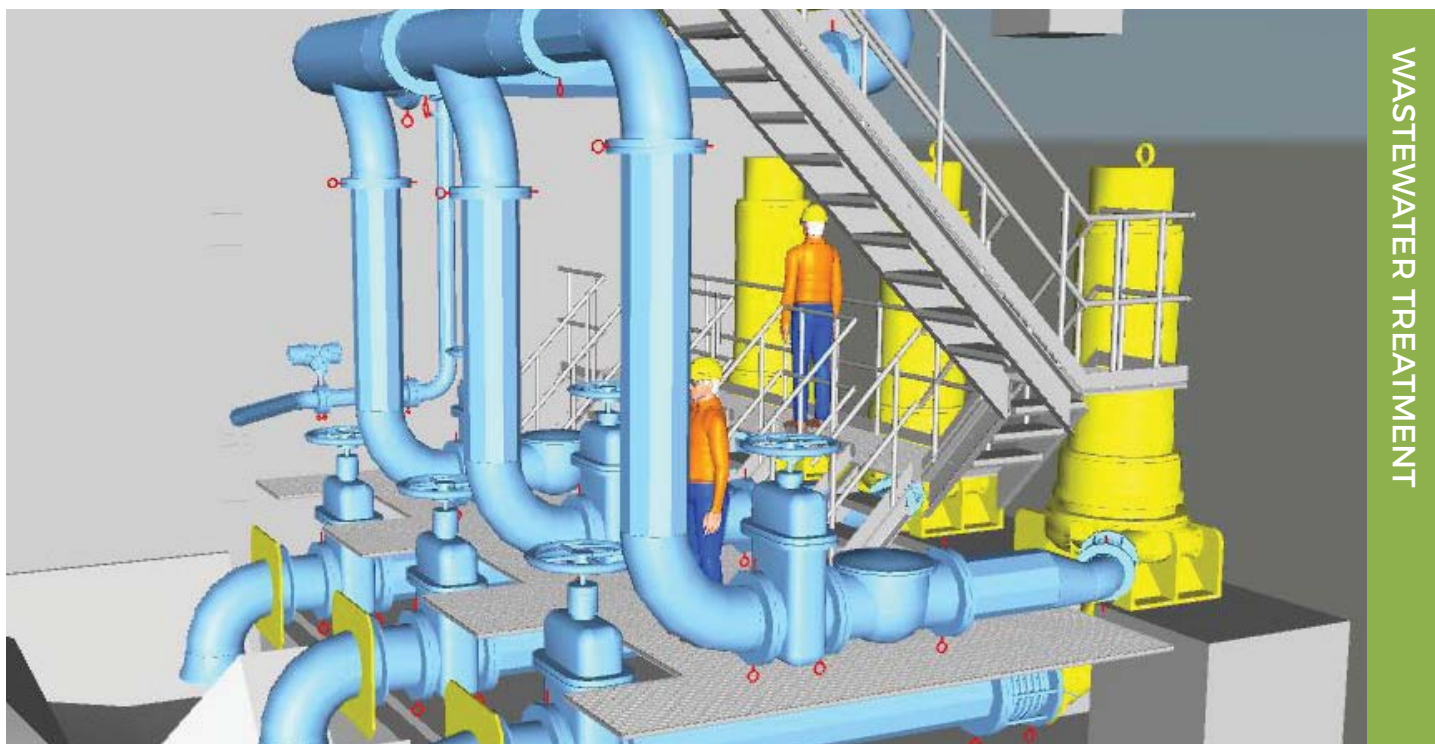

HOBSONVILLE WASTEWATER PUMP STATION

McConnell Dowell, Auckland, NZ.

PROJECT:

58 MLD Wastewater Pump Station Upgrade.

MTL ROLE:

MTL were engaged by McConnell Dowell for the mechanical (tender) design for the upgrade of the second dry well to accommodate higher capacity pumps with a wider flow range (24 MLD - 58 MLD).

The Hobsonville pump station building was constructed approximately 10 years ago, but only one dry well fitted out. The design flow requirement increased significantly since the building was originally designed. Fitting significantly larger pumps than originally intended in the space introduced a number of design challenges. Our ultimate plant layout did not compromise hydraulic design or operational and maintenance access. Thickening of the dry well floor was required to accommodate the larger pump drive vibration and deflection limits.

Pump suppliers were consulted during the design process to ensure the pump performance was not compromised particularly in the wet well which required to be reformed to optimise flow.

PROJECT OUTCOME:

The pump station design, particularly with regard to the operational and maintenance access, was well received when presented to the tender panel.

PROJECT PARTNERS:

Watercare, McConnell Dowell, Arup, Neo.

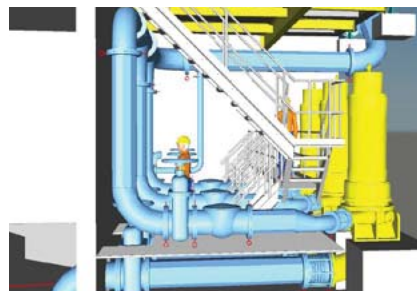
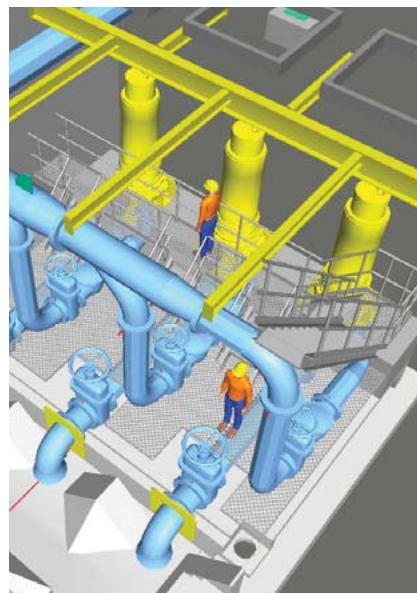



LEACHATE TREATMENT PLANT

EnviroWaste Services Ltd (ESL), Hampton Downs, NZ

PROJECT:

380m³/d Reverse Osmosis Leachate Treatment Plant.

MTL ROLE:

In order to reduce environmental impact, ESL invested in a Leachate Treatment Plant at their Hampton Downs landfill site. MTL provided engineering and contract management services for this new facility, which utilises the latest Reverse Osmosis (RO) technology. This technology helps combat the high rates of fouling, that would normally render RO plants useless in this application, and the design allows ESL to recover the water content from within the leachate.

The specialist equipment required a considerable amount of 'balance of plant' which had to be delivered within a tight budget. MTL supported ESL with engineering design, project delivery strategy, preparation and administration of NEC3 construction contracts, preparation of specifications (civil, mechanical and electrical) for a design+build contract, coordination and interfacing management, witnessing of offshore factory acceptance testing, construction monitoring and commissioning management.

PROJECT PARTNERS:

New Logic Research (California)
McMahon Electrical





MOBILE CHLORINE DOSING UNIT

Watercare Services Ltd, Auckland, New Zealand

PROJECT:

Mobile Chlorine Dosing system to boost Cl_2 residual near the end of a new CLS water main.

MTL ROLE:

MTL provided process and mechanical design, project management and commissioning services for the containerised unit to maintain Cl_2 residual due to initial low water demand. The system included the following features:

- High & low range Cl_2 gas dosing capability
- Automatic gas dosing control via PLC
- Inlet treated water and dosed treated water analysers
- Operation at water main pressures of 200 to 1600 kPa
- Hardwired emergency gas shut-off and gas leak detection systems
- HSNO compliant design
- Remote monitoring and alarms via SMS

PROJECT OUTCOME:

MTL worked very closely with Filtration Technology, the Siemens dosing equipment supplier and installation contractor to ensure the dosing unit met the high standards required.

PROJECT PARTNERS:

Ergo Consulting Ltd (Electrical & Controls) and Filtration Technology/Kinetic/PLNZ.



WORLD-CLASS RESULTS.

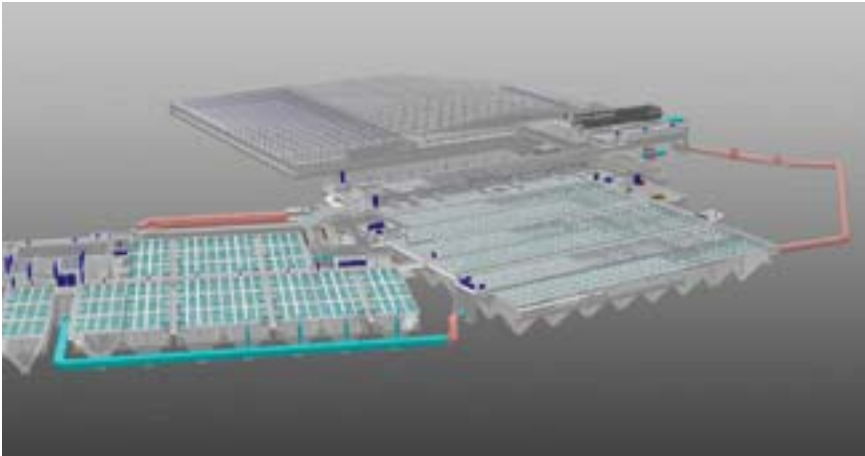

42 George Street, Mt Eden, Auckland 1024, New Zealand P: +64 9 638 3447 E: info@mtlnz.co.nz